



FS-GT2G

Digital proportional radio control system

INSTRUCTION MANUAL

用户手册

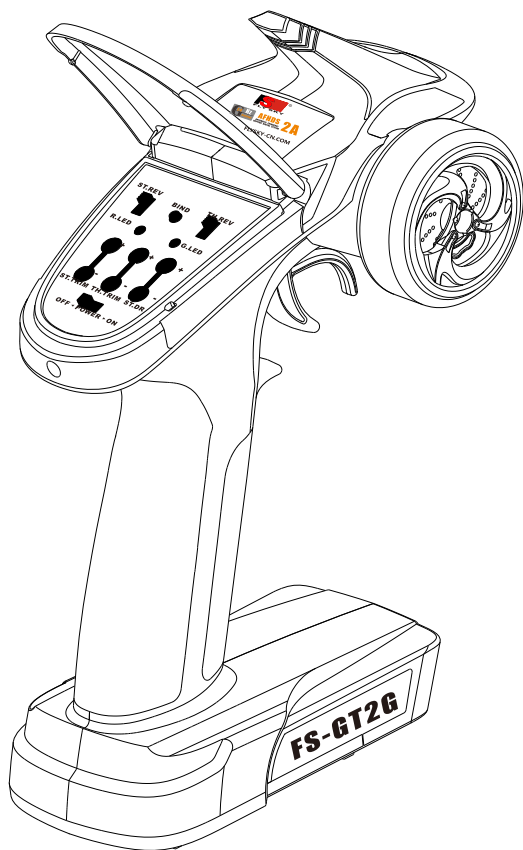

AFHDS
AUTOMATIC FREQUENCY
HOPPING DIGITAL SYSTEM

2A

<http://www.flysky-cn.com>

Table of contents



1. Introduction 简介.....	2
2. Services 服务.....	2
3. special symbols特殊标志	3
4. Safety guide 安全指导.....	3
5. 2.4GHz System/characteristic 2.4G系统/系统特征.....	5
5.01. AFHDS自动跳频数字系统.....	5
5.02. System Characteristic系统特征.....	5
5.03. AFHDS2A第二代增强版自动跳频数字系统.....	6
5.04. System Characteristic系统特征.....	6
6. AFHDS和AFHDS2A系统互换.....	7
7. Transmitter specifications 发射机参数.....	8
8. Receiver specifications接收机参数.....	8
9. Receiver and servo connections 接收机与伺服器连接.....	9
9.01. Installation when a motor controller is used带马达模型的安装连接.....	9
9.02. Installation for gas powered models发动机模型的安装.....	10
10. 2.4GHz Operation notes 2.4G操作注意事项.....	11
10.01. Mtching(code)/binding 对码.....	11
10.02. Power on开机.....	12
10.03. Shut down关机	12
11. Each part of the transmitter.发射机部件.....	13
12. Transmitter function notes发射机功能说明.....	14
12.01. Steering control 方向控制.....	14
12.02. Throttle control油门控制.....	15
13. Failsafe function接收机操作说明.....	16
13.01. Failsafe instruction 失控保护功能说明.....	16
14. Simulate模拟.....	17
15. Packaging content包装内容	18
16. FCC Statement 声明	18

1. Introduction 简介

Thank you for choosing 2.4G ratio remote control digital products,if you are the first time to use this type of products,please read this statement carefully and strictly in accordance with the requirements of operation.You could refer to the manual if you meet any problems during the operation.Please well keep the manual after use because you might have to use it again next time.Once again,thanks for buying our products.

感谢您选择使用 FS-GT2G 2.4G 数码比率遥控产品，如果你是第一次使用该类型产品，请您在使用之前先仔细阅读此说明书，并严格按说明要求进行操作。在操作过程中您如果遇到同样可以查看说明书。说明书在使用完后请您妥善保管好，以备后用。再次感谢您使用 FS-GT2G 的产品，并希望给您带来快乐。

2. Services 服务

If you find any problems during the operation process,please refer to the manual.If the problem still exist,you could contact our dealers to find out the way to solve.And you could also log on to our website service center:

<http://www.flysky-cn.com>

如果您使用过程中发现有问題，请您第一时间先查看说明书。如果问题还不能解决，您可以跟我们的经销商联系解决。您也可以登录我们的服务中心网站：

<http://www.flysky-cn.com>

3. Special symbols 特殊标志

Please pay attention to the following symbols when it appears on the manual and read carefully.

此说明书中有如下符号的地方请您特别注意，并仔细阅读。



Danger:

If the operator does not operate by following the instructions, the operator may lead to serious injuries, even mortal danger.

如果操作者不按正常操作方法操作，有可能导致操作者严重受伤，甚至致命危险。



Warning:

If the operator does not operate by following the instructions, the operator may lead to serious injuries, even mortal danger.

如果操作者不按正常操作方法操作，可能导致操作者严重外伤，重伤或者致命情况！



Attention:

If the operator does not operate by following the instructions, the operator may lead to minor injuries, but generally it will not cause serious injuries to the operator.

如果操作者不按正常操作方法操作，可能会导致操作者轻伤，但一般不会对操作者造成重伤！



Prohibited
禁止



Mandatory
强制

4. Safety guide 安全指导



Do not use it in the night or a lighting storm as the bad weather will make the remote control out of control.

请不要在夜晚或者雷雨天使用此产品，因为恶劣的天气环境有可能导致遥控设备失控。



Make sure moving direction of all motors be same with the operating direction. If not, please adjust direction first.

操控时，请先确认模型所有舵机的动作方向与操控方向一致。如果不一致，请调整好正确的方向。



The shutdown sequence must be to first disconnect the receiver battery then to switch off the transmitter. If the transmitter is switched off while the receiver is still powered, it may lead to uncontrolled movement or engine start and may cause an accident.

关闭时，请务必先关闭接收机电源，然后关闭发射机，如果关闭发射机电源时接收机仍然在工作，将有可能导致遥控设备失控或者引擎继续工作而引发事故。



In particular, the 2.4G R/C system will affect the plane or the car nearby after you turn on the transmitter.

特别要注意，如果附近有汽车正在运行或飞机正在飞行，开机后2.4 GHz RC系统可能会影响到他们。



Be sure to set the Fail Safe function.

一定要启用防失控功能。



Do not operate outdoors on rainy days, run through puddles of water or use when visibility is limited. Should any type of moisture (water or snow) enter any component of the system, erratic operation and loss of control may occur.

不要在户外雨天,有水的地方或当能见度有限的时候使用。可能水分(水或雪)会进入到系统内部,不稳定的运行和失控可能发生。



Do not operate in the following places.

- Near other sites where other radio control activity may occur.
- Near people or roads.
- On any pond when passenger boats are present.
- Near high tension power lines or communication broadcasting antennas.

Interference could cause loss of control. Improper installation of your Radio Control System in your model could result in serious injury.

不要操作在以下的地方。

基站附近或其他无线电活跃的地方；

人多的地方或道路附近。

有客船的水域。

高压电线或通信广播天线附近。

干扰可能导致失控。安装不正确,无线电控制系统可能导致模型发生严重的伤害。



Do not operate this R/C system when you are tired, not feeling well or under the influence of alcohol or drugs.

Your judgment is impaired and could result in a dangerous situation that may cause serious injury to yourself as well as others.

当你感到疲倦,饮酒或吸毒后,不舒服的影响下,不要操作这个R/C系统。判断力下降,而且可能发生危险的情况下,对自己或他人可能造成严重的伤害。



Do not touch the engine, motor, speed control or any part of the model that will generate heat while the model is operating or immediately after its use. These parts may be very hot and can cause serious burns.

当模型操作或使用后,请勿触摸发动机、电机、调速器或任何可能发热的部分,这些部分可能非常热,会造成严重的烧伤。



Always perform a operating range check prior to using.

Problems with the radio control system as well as improper installation in a model could cause loss of control. (Simple range test method) Have a friend hold the model, or clamp it down or place it where the wheels or prop cannot come in contact with any object. Walk away and check to see if the servos follow the movement of the controls on the transmitter. Should you notice any abnormal operation, and do not operate the model. Also check to be sure the model memory matches the model in use.

总是在操作模型之前进行全面的检查。

无线电控制系统出现问题以及不正确安装,都有可能导致模型失控,简单的距离测试方法:

一个人把持模型,或者提起来让轮子与地面无法接触,另一个人持发射机走开,检查该伺服系统运转情况。测试时要注意到若有异常出现,请不要操作模型。也检查模型的记忆,以确保模型的匹配是适当的。



Turn on the power:

Turning on the power switches, Always check the throttle trigger on the transmitter to be sure it is at the neutral position.

When making adjustments to the model, do so with the engine not running or the motor disconnected. You may unexpectedly lose control and create a dangerous situation.

开机时,每次都要检查发射器的油门中位是不是处于中间位置。

当发射机作出调整时,可能模型的引擎没有运行或电机没有连接。可能会发生失控或意外事故的情况。

5. 2.4GHz System/Characteristic 2.4G系统/系统特征

5.01. AFHDS 自动跳频数字系统



AFHDS (automatic frequency hopping digital system),is developed by **FLYSKY** for all the Radio Control model lovers and is patented by **FLYSKY** at home.The system is specially developed for all the Radio control models,**thar** offers super active and passive antijamming capabilities,very low power consumption and high receiver sensitivity.With extreme rigorous testing by engineers and studying the markets for years,**FLYSKY AFHDS** is now considered to be the one of the best systems available in the market.

AFHDS(自动跳频数字系统),这个系统是富斯公司专为模型爱好者自主研发,并具有自主知识产权的一套数字无线系统。它是专门针对模型产品而研发的,它具有超强的主动和被动抗干扰能力及极低的使用功耗和极高的接收灵敏度,是目前市面上最好的系统之一。此系统经过研发人员极端严格的测试及多年市场验证,模型爱好者完全可放心使用!

RF specifications:

RF range: 2.405-2.475GHz
Bandwidth: 500KHz
Band sum: 141
RF power: less than 20dBm
2.4G system: AFHDS
Code type: GFSK
Antenna length: 26mm
RX sensitivity: -98dBm

参数说明:

频率范围: 2.405-2.475GHz
波段宽度: 500KHz
波段个数: 141个
发射功率: 不高于20dBm
2.4G模式: 自动跳频数字系统
编码方式: GFSK
天线长度: 26毫米
接收机灵敏度: -98dBm

5.02. System Characteristic 系统特征

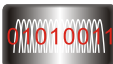

This radio system works in the frequency range of 2.405 to 2.475GHz. This band has been divided into 141 independent channels. Each radio system uses 16 different channels and 142 different types of hopping algorithm. By using various switch-on times, hopping scheme and channel frequencies, the system can guarantee a jamming free radio transmission.

此系统工作频率范围是2.405到2.475GHz。整个波段被分为141个独立频点。每套遥控系统使用16个不同频点和142种不同的跳频算法。通过开机时间不同,跳频规律不同和使用不同的频点,遥控系统能避免干扰传播信号。



This radio system uses a high gain and high quality multi directional antenna. It covers the whole frequency band. Associated with a high sensitivity receiver, this radio system guarantees a jamming free long range radio transmission.

此系统采用高质量的增益天线,覆盖整个波段带宽。配合高灵敏度接收机,系统能有效的避免远距离传播信号的干扰。



Each transmitter has a unique ID. When binding with a receiver, the receiver saves that unique ID and can accepts only data from that unique transmitter. This avoids picking another transmitter signal and dramatically increases interference immunity and safety.

每台发射机有一个唯一的ID码,当和接收机对码之后,接收机保存这个唯一的ID码并且只接受从这个ID码发射机发出的信号。这样可以避免接收到别的发射机信号,大大增强抗干扰能力和安全性。



This radio system uses low power electronic components and a very sensitive receiver chip. The RF modulation uses intermittent signal transmission thus reducing even more power consumption. Comparatively, this radio system uses only a tenth of the power of a standard FM system.

此系统使用低功率电子元件和高灵敏度接收机芯片。无线电频率模块采用间歇性信号传播,因此大大降低了发射功率。比较而言,此系统功耗仅为FM版本的十分之一。

5.03. AFHDS2A 第二代增强版自动跳频数字系统



AFHDS2A (automatic frequency hopping digital system 2A) is the digital radio system with independent intellectual property, which is newly developed by FLYSKY. This system is developed specially for high-end model products. As the one of the best system in the market, it has built-in multiple channel coding, error-correction, longer communication distance and more powerful antijamming capability. Model airplane fan can safely use this radio system as it combines years of design experience and has passed stick field tests.

AFHDS2A (第二代增强版自动跳频数字系统)是富斯公司基于AFHDS/AFHDS2基础最新研发成功的一套数字无线系统,具备自主知识产权。AFHDS2A专门针对高端模型产品而研发,内置多重信道编码和纠错算法,采用主动和被动跳频方式,具备更强的通信距离和抗干扰能力,是目前市面上最好的无线系统之一。此系统融合了富斯研发人员多年的设计经验,通过严格的现场测试,航模爱好者可放心使用!

RF specifications:

RF range: 2.405-2.475GHz
Bandwidth: 500KHz
Band sum: 141
RF power: less than 20dBm
2.4G system: AFHDS 2A
Code type: GFSK
Antenna length: 26mm
RX sensitivity: -98dBm

参数说明:

频率范围: 2.405-2.475GHz
波段宽度: 500KHz
波段个数: 141个
发射功率: 不高于20dBm
2.4G模式: 第二代增强版自动跳频数字系统
编码方式: GFSK
天线长度: 26毫米
接收机灵敏度: -98dBm

5.04. System Characteristic 系统特征

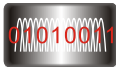

The frequency range of AFHDS2A is from 2.405GHZ to 2.475GHZ. The whole band is divided into 141 frequency points. Each system with unique frequency hopping rules uses 16 different frequency points, which can avoid interruptions effectively.

AFHDS2A系统工作频率范围为: 2.405-2.475GHz。整个波段被划分为141个独立频点。每套遥控系统使用16个不同频点,具备独立的调频规律,能有效的避免信道间的干扰。



This radio system uses a high gain and high quality multi directional antenna. It covers the whole frequency band. Associated with a high sensitivity receiver, this radio system guarantees a jamming free long range radio transmission.

此系统采用高质量的增益天线,覆盖整个波段带宽。配合高灵敏度接收机,系统能有效的避免远距离传播信号的干扰。



Each transmitter has a unique ID. When binding with a receiver, the receiver saves that unique ID and can accept only data from that unique transmitter. This avoids picking another transmitter signal and dramatically increases interference immunity and safety.

每台发射机有一个唯一的ID码,当和接收机对码之后,接收机保存这个唯一的ID码并且只接受从这个ID码发射机发出的信号。这样可以避免接收到别的发射机信号,大大增强抗干扰能力和安全性。



This radio system uses low power electronic components and a very sensitive receiver chip. The RF modulation uses intermittent signal transmission thus reducing even more power consumption. Comparatively, this radio system uses only a tenth of the power of a standard FM system.

此系统使用低功率电子元件和高灵敏度接收机芯片。无线电频率模块采用间歇性信号传播,因此大大降低了发射功率。比较而言,此系统功耗仅为FM版本的十分之一。



AFHDS2A has built-in multiple channel coding and error-correction, which improve the stability of the communication, reduce the error ratio and extend the reliable transmission distance.

AFHDS2A系统内置多重信道编码和纠错算法，有效的提高了通信稳定度，减小通信误码率，增加可靠传输距离。

6. Switching system between system AFHDS and system AFHDS 2A AFHDS和AFHDS2A系统切换

手轮任意方向拧到底同时按住“BIND”键开机，进行AFHDS和AFHDS2A系统切换。

开机后，如果发射机绿色LED灯常闪，表示当前系统为AFHDS，按“BIND”键存储当前系统。

如果发射机绿色LED灯闪两下停一下(闪烁周期为1.3 S)，表示当前系统为AFHDS2A。按“BIND”键存储当前系统。

系统切换完成后，重启发射机，即可使用当前系统。

System switching: turn the steering wheel and press the "BIND" button when turn the transmitter on.

The current system is AFHDS if the green LED keeps flashing. Press the "BIND" button to save the current system.

The current system is AFHDS 2A if the green LED flashes twice every time. Press the "BIND" button to save the current system.

Restart the transmitter, and the current system is what you saved before.

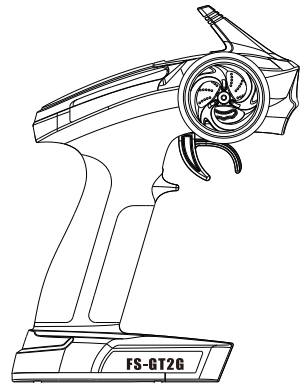

Digital proportional radio control system **FS-GT2G**

7. Transmitter specifications 发射机参数

Transmitter specifications:

Channels: 2
Model type: car/boat
RF range: 2.405-2.475GHz
Bandwidth: 500KHz
Band: 141
RF power: less than 20 dBm
2.4G system: AFHDS 2A and AFHDS
Code type: GFSK
Sensitivity: 1024
Low voltage warning: less than 4.2V
DSC port: 3.5mm ; output: PPM
ST range: 70 L:35 R:35
TH range: 45 F:35 B:15
Charger port: no
ANT length: 26mm
Weight: 239g
Power: 6V DC 1.5AA*4
Display mode: LED indicator
Size: 210*95*160mm
Color: black

机种参数

通道个数: 2
适合机种: 车/船
频率范围: 2.405-2.475GHz
波段宽度: 500KHz
波段个数: 141个
发射机功率: 不高于20dBm
2.4G模式: 第二代增强版自动跳频数字系统(含第一代系统)
编码方式: GFSK
通道分辨率: 1024级
低电压报警: 低于4.2V时
数据输出: 3.5毫米音频接口 PPM
方向盘转动角度: 45度(前35度, 后15度)
充电接口: 无
天线长度: 26毫米
机身重量: 239克
输入电源: 6V DC 1.5AA*4
显示方式: LED指示灯
外形尺寸: 210*95*160毫米
外观颜色: 黑色



MODELS: FS-GT2G

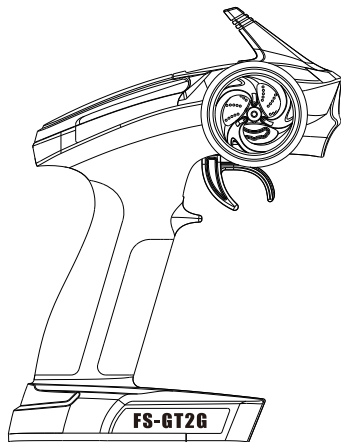

8. Receiver specifications 接收机参数



MODEL: FS-A3

SPECIFICATIONS :

Channels: 3
Model type: car/boat
RF range: 2.405-2.475GHz
Bandwidth: 500KHz
Band sum: 141
RF receiver sensitivity: -98dBm
2.4G system: AFHDS 2A
Code type: GFSK
Sensitivity: 1024
Power: 4.0-6.5V DC
ANT length: 26mm
Weight: 5g
Size: 35*22*12mm
Color: black
Certificate: CE FCC

机种参数:

通道个数: 3
适合机种: 车/船
频率范围: 2.405-2.475GHz
波段宽度: 500KHz
波段个数: 141个
接收灵敏度: -98dBm
2.4G模式: 第二代增强版自动跳频数字系统
编码方式: GFSK
通道分辨率: 1024级
输入电源: 4.0-6.5V DC
天线长度: 26毫米
机身重量: 5克
外形尺寸: 35*22*12毫米
外观颜色: 黑色
认证: CE FCC

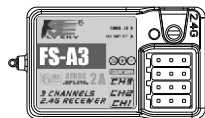

9. Receiver and servo connections 接收机与伺服器连接

9.01. Installation when a motor controller is used

带马达模型的安装连接

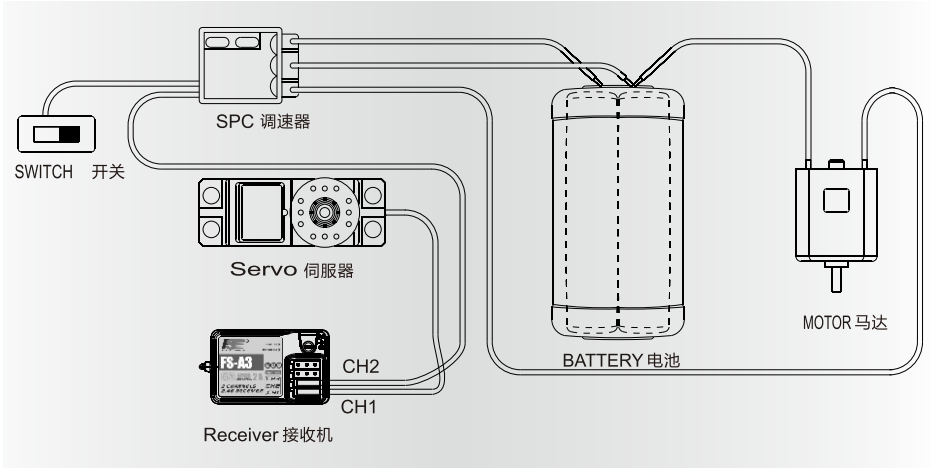

Remark: Place the receiver antenna upright and perpendicular to the horizontal plane
Keep the receiver antenna away from any metal objects to ensure max sensitivity. (See pic1)



注：在安装接收机时请将接收机天线与水平面垂直放置！且天线尽可能不要靠近金属物！因为这样接收灵敏度最高。（如图1）

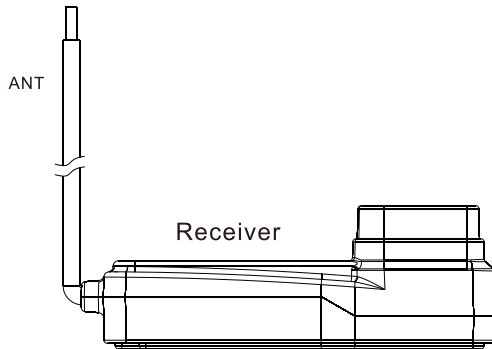
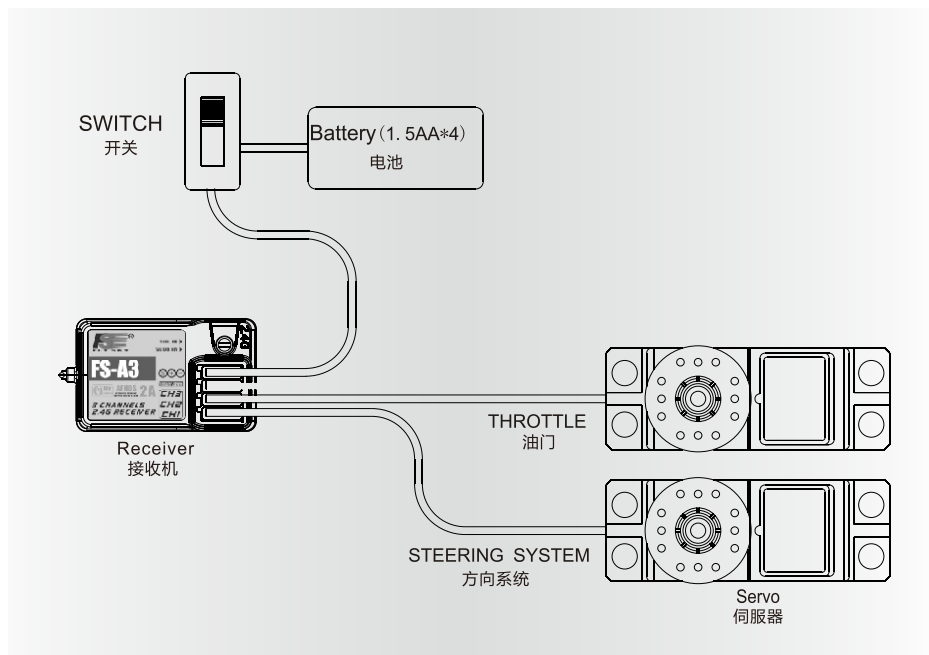

Figure1 (图1)

9. 02. Installation for gas powered models 发动机模型的安装



10. 2.4GHz Operation notes 2.4G操作注意事项

10.01. Matching(code)/Binding 对码

All receivers are already paired with their respective transmitter during production. If you wish to bind it with another transmitter, please follow the instructions below.

Remark: FS - brand system are not compatible with other brands

Steps:

1. Ensure you are using AFHDS2A system
2. Correctly install the battery inside 2.4G transmitter w/o powering it on.
3. Insert the binding plug into the BIND channel slot on the receiver. (Figure.1).
4. Using a correct receiver battery pack, plug it in to VCC channel slot on the receiver. At this time, the LED on receiver should flash, indicating receiver has entered bind status.
5. Press and hold the binding button on transmitter, and then switch on the transmitter.
6. Observe the LED light on the receiver. If LED stops flashing, and stays lit permanently, the binding procedure is completed. (This process takes approximately 5S.)
7. Release the binding button on the transmitter, and unplug the bind cable.
8. Install the servos to test.
9. If the system does not work properly, repeat the procedure. (The above binding instruction is only suitable for any FLYSKY 2.4G products)

我们的产品出厂前已经过配对，您无需做配对动作便可使用。但如果您要将接收机跟另外的发射机进行配对使用，或者您要更换新的接收机或者发射机，请您按如下的步骤进行：

注：我们的接收发射系统。不跟其它品牌兼容！

1. 确保发射机为AFHDS2A系统
2. 将2.4G发射机装好电池，并关闭发射机。
3. 将配对线插入接收机的BIND通道接口（如图1）
4. 将接收机电池插入接收机的VCC通道接口，此时可看到接收机的LED在闪烁，此表示接收机进入配对状态。
5. 将发射机上的配对键（BIND）按住，然后打开发射机电源开关。（注：不要松开按键）。
6. 观察接收机上的LED，如果发现LED由快闪烁变为慢闪烁表示配对成功。（注：此过程大约时间为5S左右）。
7. 松开发射机上的配对按键，电源开关重启一次；拔掉接收机上的配对线，电源线要插到VCC的位置。
8. 将伺服器装上并通电测试
9. 如果测试NG，则重复以上动作

注：以上配对方法，仅适合于FLYSKY的2.4G产品。

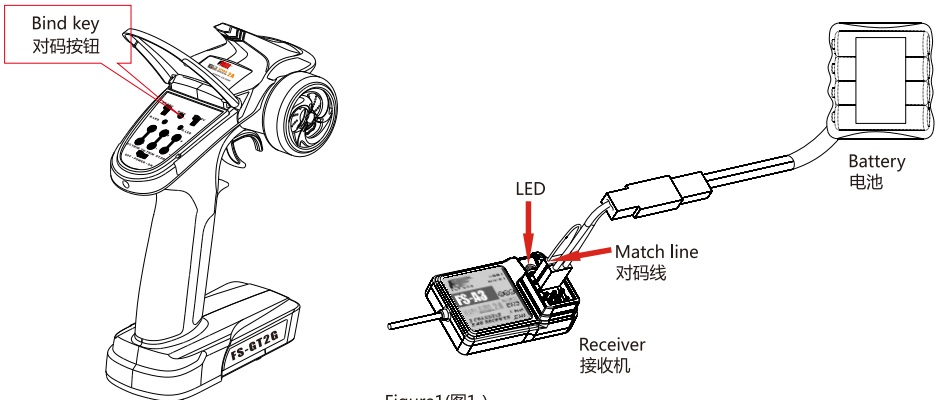
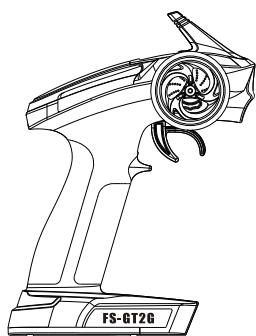

Figure1(图1)

10.02 Power on 开机

- A. Connect every part.
- B. Switch on the power supply of the transmitter.
- C. Connect the power supply of the receiver.
- D. Receive LED light solid.
- E. Finish and use.

1. 将各部件链接好；
2. 打开发射机电源开关；
3. 连通接收机电源；
4. 接收机LED恒亮；
5. 使用。



Tx power ON

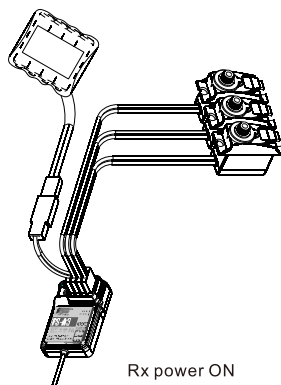
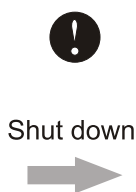

Rx power ON

10.3 Shut down 关机

- A. Connect every part.
- B. Cut off the transmitter power supply.

1. 关闭接收机的电源；
2. 关闭发射机的电源。

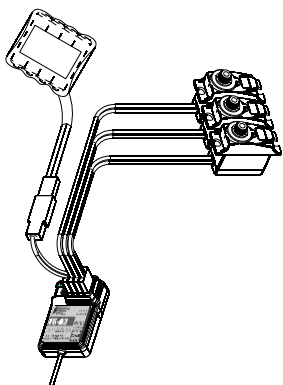

Rx power off

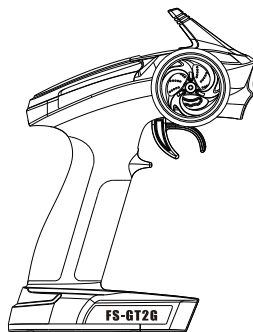
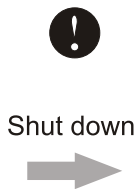

Tx power off

11. each part of the transmitter 发射机部件

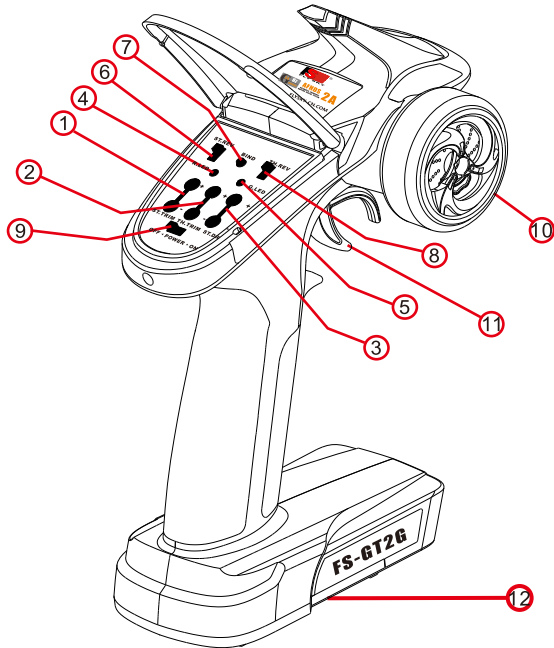

- | | | |
|---------------------|-----------------------|-------------------------|
| ① ST 中位微调 ST TRIM | | |
| ② TH 中位微调 TH TRIM | | |
| ③ ST 通道比例微调 ST D/R | | |
| ④ 电源指示灯 POWER LED | | |
| ⑤ 工作指示灯 POWER CHECK | ⑧ TH 倒置开关 TH REV | |
| ⑥ ST 倒置开关 ST REV | ⑨ 开关 ppower | ⑪ 油门扳机 THROTTLE TRIGGER |
| ⑦ 对码键 BIND Key | ⑩ 方向调轮 STEERING WHEEL | ⑫ 电池盒 BAT BOX |

12. Transmitter function notes 发射机功能说明

12. 01. Steering control 方向控制

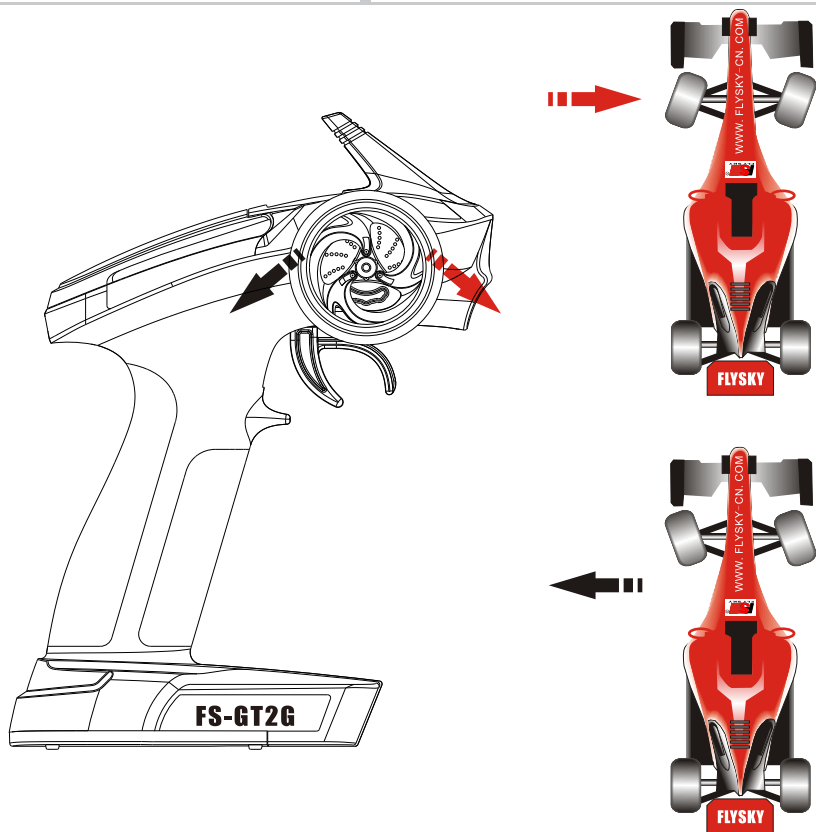

Function Introduction:

This function is to control the direction, when the steering turn to right then the front wheel will turn to right (as picture), when the steering turn to left then the front wheel will turn to left (as picture).

Operation Method:

Adjust the dual rate of the steering by adjusting the D/R knob.

功能说明：

此功能是用来进行方向控制，当方向舵往右旋转时车子前轮会跟着往右（如图），当方向舵往左旋转时车子前轮会跟着往左（如图）。

操作方法：

开机后，通过方向舵进行方向控制，方向舵动作大小依据实际情况进行比率调整，方向舵大小动作量可通过D/R进行大小舵量的调整。

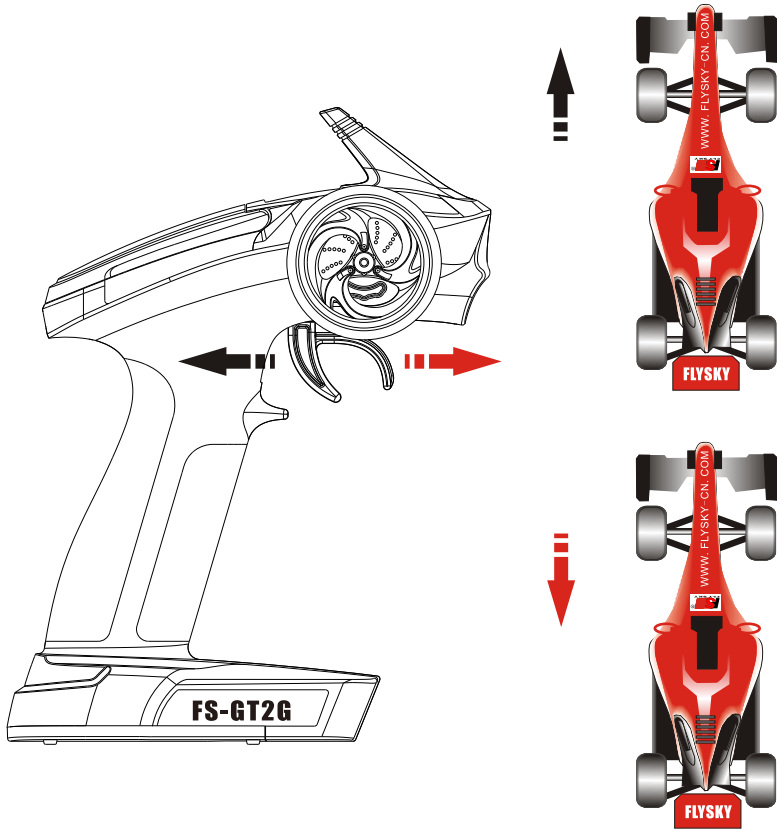

Function Introduction:

This function is to control the throttle speed, when pull the rhotte trigger back, car will accelerate forward (see the picture), when push the throttle trigger, the car will put on the brakes or double ring asterm (according to the different ESC) (see the picture).

Operation Method:

To control it by pushing and pulling back the throttle trigger after power on.

功能说明：

此功能是用来进行油门（速度）控制，当油门扣机往后打时车子会向前加速（如图），当油门扣机往前推时车子会进行刹车或加速后退（依据不同的调速器）（如图）。

操作方法：

开机后，通过油门扣机进行前后运行的控制。

13. Fail safefunction

接收机操作说明

13.01 Failsafe Instruction

失控保护功能说明

FAIL SAFE FUNCTION

1. Function

Failsafe aims to prevent out-of-control driving of RC car or RC boat. If the Receiver is not able to receive any signal, from the control to throttle, the parameter of throttle on receiver will turn back to its original setting.

2. Setting

- Turn on the Transmitter switch;
- Turn on the Receiver switch, the LED will be lighting;
- Adjust Transmitter's Throttle, make the car/boat to stop or flameout, then keep still.
- Press the "Setting" button on Receiver (as the pic below). the LED will be flashing, then stop after 3 seconds around, which means setting finished.

3. Testing

- Turn on the Transmitter switch;
- Turn on the Receiver switch;
- Turn off the transmitter switch;
- Servo of throttle will turn back to its original setting automatically;
- Setting is successful if above procedures finished completely.

1.功能说明

失控保护功能是对模型车或船进行失控保护，避免因失控造成损失。主要是对油门通道进行控制，当接收机接收不到控制信号时，接收机的油门通道将自运行到当初设定的值，以免误动作。

2.设定方法

- 将发射机开通电源进入工作状态。
- 将接收机接通电源进入工作状态，此时信号灯恒亮。
- 控制发射机的油门通道，使油门控制伺服器或调速器进入刹车或熄火状态，然后保持不动。
- 此时将接收机的设定键（如图按下），此时接收机LED信号灯会闪烁，并在3秒左右停止。
- 设定完成

3.测试

- 将发射机打开进入工作状态。
- 将接收机接通电源进入工作状态。
- 将发射机关闭电源。
- 此时可看到油门通道的伺服器便会自动进入设定状态的位置
- 以上动作如果可以完成表示设定OK

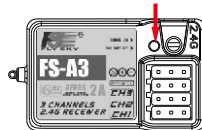

14. Simulation 模拟

Introduction:

The following is for the virtual RC racing practice on computer, and you can also play simulated competition on the computer.

Operation Methods:

1. Use the FS-SM100 simulator cable to connect the transmitter and computer
2. Switch on the Transmitter.
3. Start VRC software on your PC.
4. Follow the on-screen instructions to customize user setting

Remark:

VRC software provided is free and only offers one track and training ground.

If all works fine, and your pc or notebook is capable of running the VRC software, you can then purchase any additional game packs from VRC company.

功能说明：

此功能用于电脑模拟，从而可通过电脑进行练习，及进行电脑模拟比赛。

操作方法：

1. 将本厂提供的电脑模拟连接线（FS-SM100）一端插入发射机的音频接口，另一端插入电脑的USB接口，
2. 打开发射机电源。
3. 启动VRC车模应用软件。
4. 按软件要求进行设定完成后便可进行电脑模拟了。

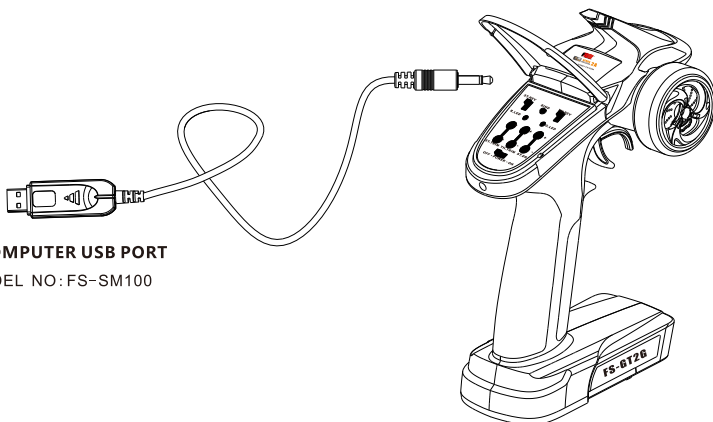
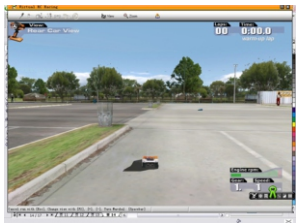

备注：

本公司提供的是VRC公司的免费软件，此软件只提供一条基本赛道和一个训练场。如需其它赛道请跟VRC公司联系。谢谢！



Digital proportional radio control system **FS-GT2G**

15. Packaging content 包装内容

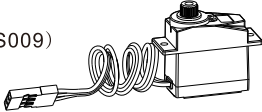
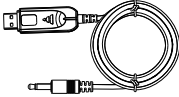
NO:	Model	Sum	Remarks
1	2 channel 2.4G transmitter(FS-GT2G) 2 通2.4G发射 	1	
2	3 channel 2.4G receiver(FS-A3) 3 通2.4G接收 	1	
3	Manual 说明书 	1	
5	Servo(FS-S009) 伺服器 	2	Optional 可选的
6	FS-SM100 模拟线 	1	Optional 可选的

16. FCC Statement 声明

FCC Statement

This equipment has been tested and found to comply with the limits for a Class B digital device pursuant to part 15 of the FCC rules. These limits are designed to provide reasonable protection against harmful interference in a residential installation. This equipment generates, uses and can radiate radio frequency energy and, if not installed and used in accordance with the instructions, may cause harmful interference to radio communications. However, there is no guarantee that interference will not occur in a particular installation. If this equipment does cause harmful interference to radio or television reception, which can be determined by turning the equipment off and on, the user is encouraged to try to correct the interference by one or more of the following measures:

- Reorient or relocate the receiving antenna.
- Increase the separation between the equipment and receiver.
- Connect the equipment into an outlet on a circuit different from that to which the receiver is connected.
- Consult the dealer or an experienced radio/TV technician for help.

To assure continued compliance, any changes or modifications not expressly approved by the party responsible for compliance could void the user's authority to operate this equipment. (Example use only shielded interface cables when connecting to computer or peripheral devices).

This equipment complies with Part 15 of the FCC Rules. Operation is subject to the following two conditions:

- (1) This device may not cause harmful interference, and
- (2) This device must accept any interference received, including interference that may cause undesired operation.

Caution!

The manufacturer is not responsible for any radio or TV interference caused by unauthorized modifications to this equipment. Such modifications could void the user authority to operate the equipment.



Digital propotional radio control system

<http://www.flysky-cn.com>

Copyright ©2013-2017 Flysky co., ltd